

NOTES

- a. ALL DIMENSIONS ARE IN INCHES, [] = MM
- b. TERMINALS ARE CLOCKWISE FROM PIN #1

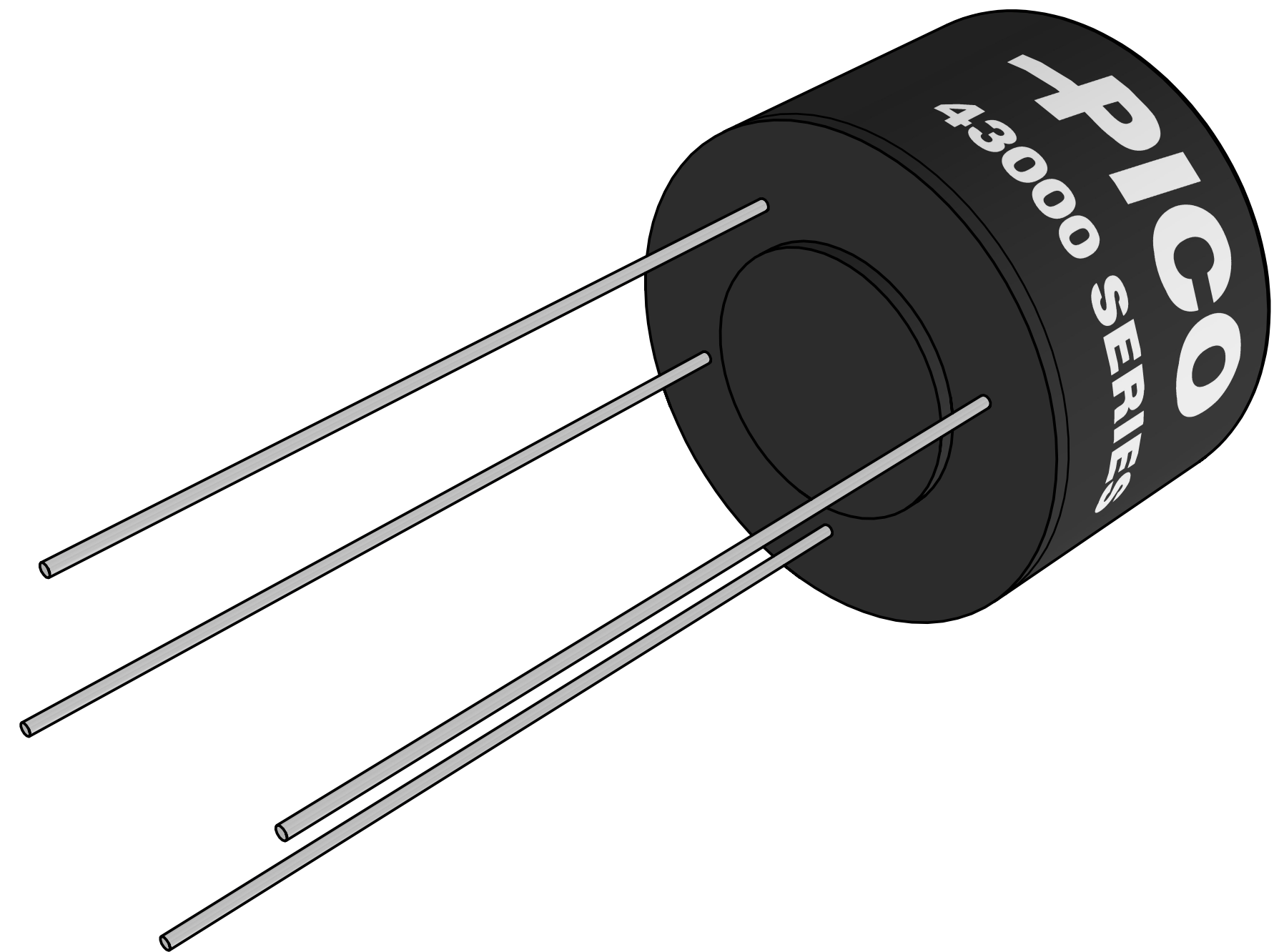
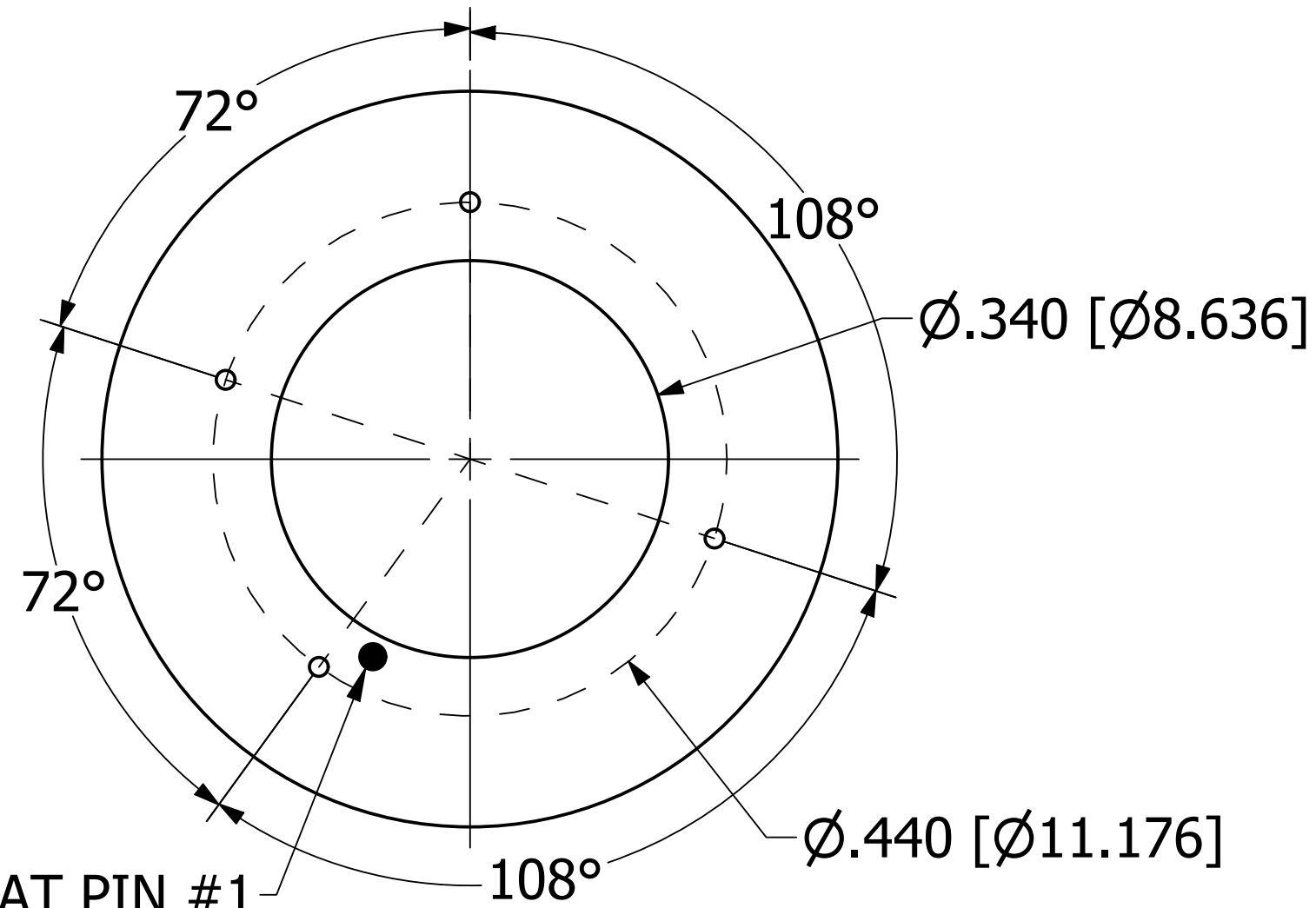
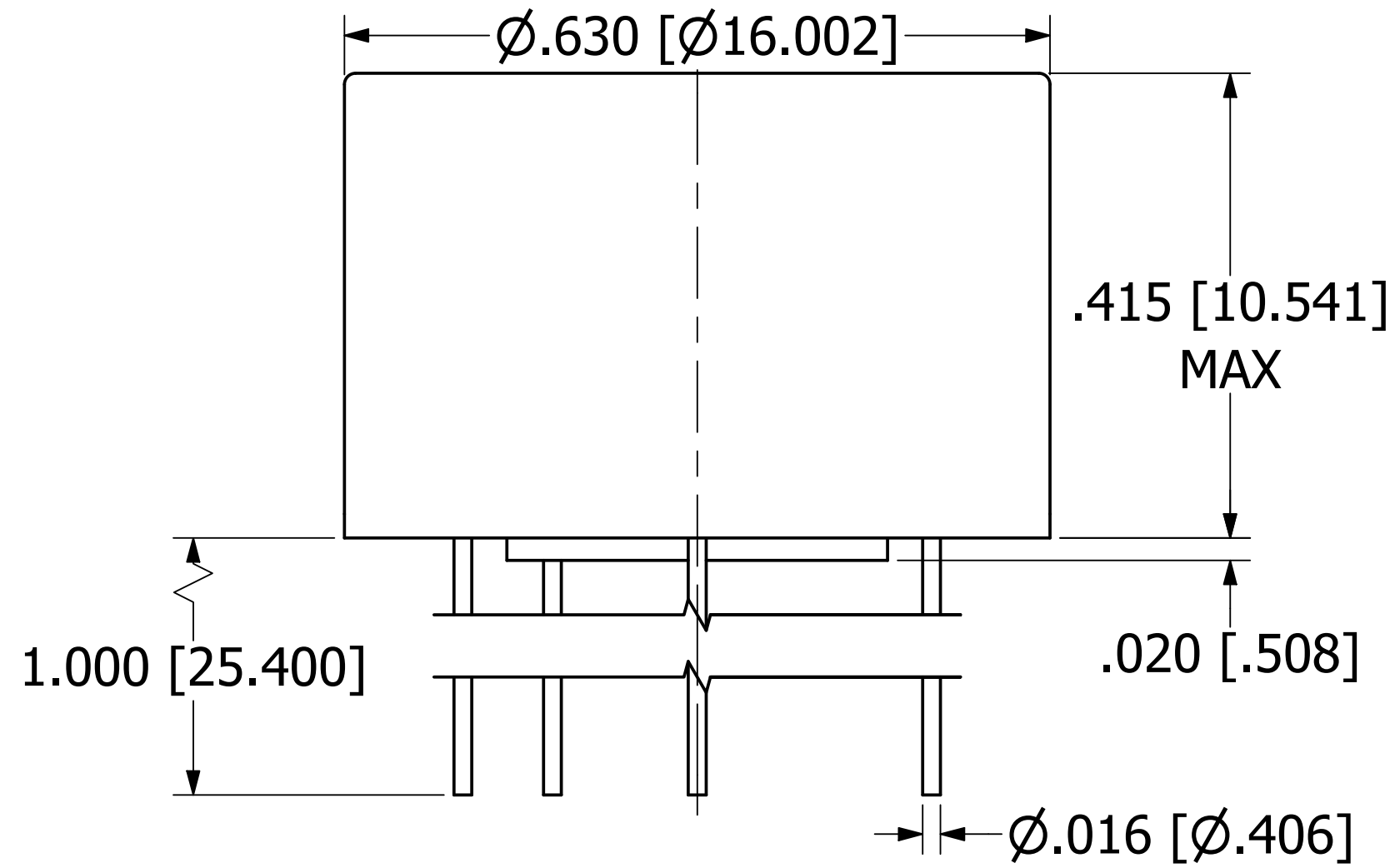

WHITE DOT AT PIN #1

BOTTOM VIEW

PROPRIETARY AND CONFIDENTIAL

THE INFORMATION CONTAINED IN THIS DRAWING IS THE SOLE PROPERTY OF PICO ELECTRONICS INC. ANY REPRODUCTION IN PART OR AS A WHOLE WITHOUT THE WRITTEN PERMISSION OF PICO ELECTRONICS INC. IS PROHIBITED

DRAWN	P.PALUCH	PICO	143 Sparks Ave	
CHECKED	H. VIDAURRE		Village of Pelham, NY 10803	
QA		Electronics		
MFG		43000 SERIES		
APPROVED		SIZE	DWG NO	REV
REVISION DATE	06/06/2023	C		1
		SCALE	NTS	www.picoelectronics.com